

2.6 Install Direction

2.6.1 – Installation of Cabinet

Step 1. Remove the compressor door/PC door & monitor door from the monitor cabinet.

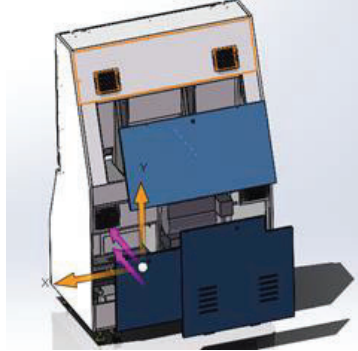

Step 2. Assemble the water storage box onto the monitor frame (4 nuts).

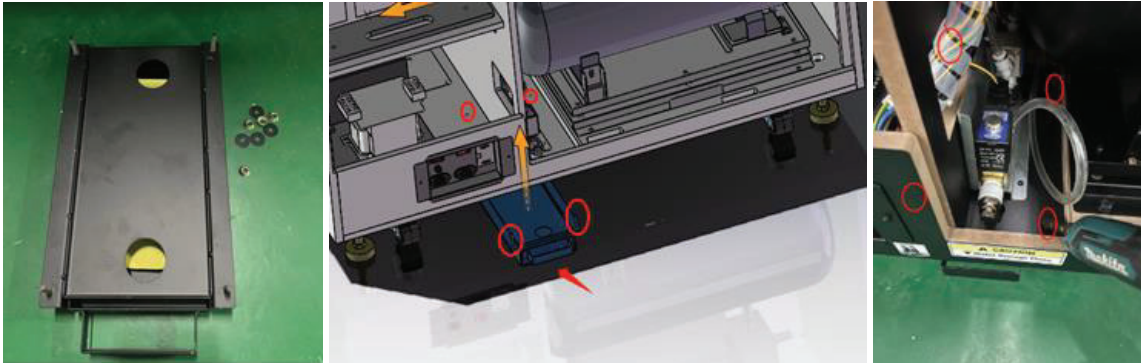

Step 3. Remove the LED PANEL ASSY back cover & bracket.

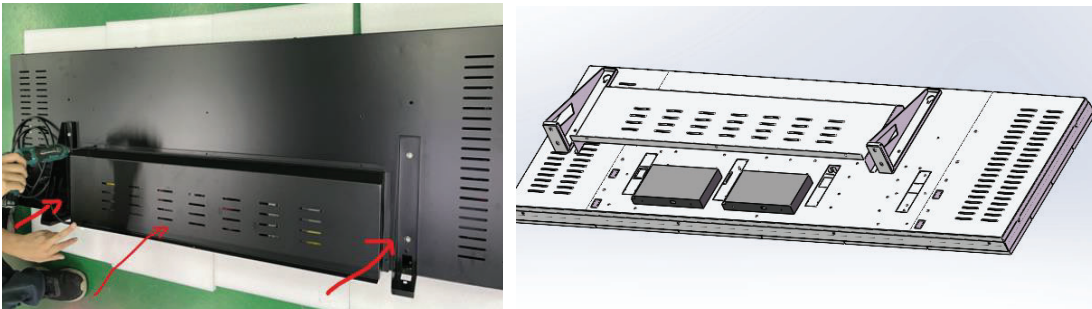

Step 4. Fix the bracket to the top of monitor frame (4 screws).

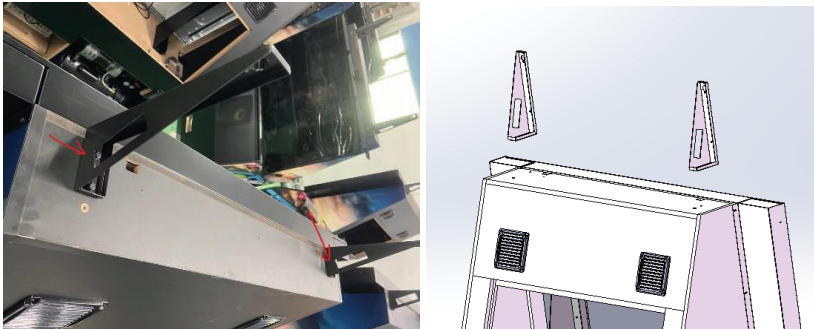

Step 5. Insert two screws into the top holes on the LCD panel (2-3 turns) and hang the LED PANEL onto the bracket. Insert and tighten the bottom two screws through the bracket and into the LED panel and tighten all 4 screws. **(NOTE: Minimum of 3 people to complete this step)**

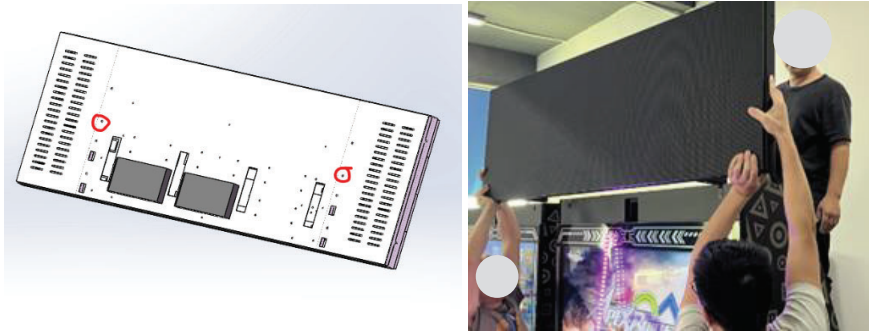

Step 6. Connect the power cable from the LED panel to the receptacle inside the back of the game.

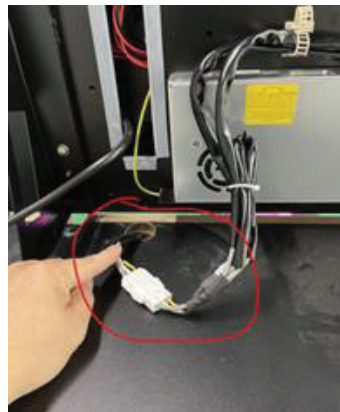

Step 7. Connect the HDMI cable between the PC (Lower left rear door of the cabinet and the LED panel).

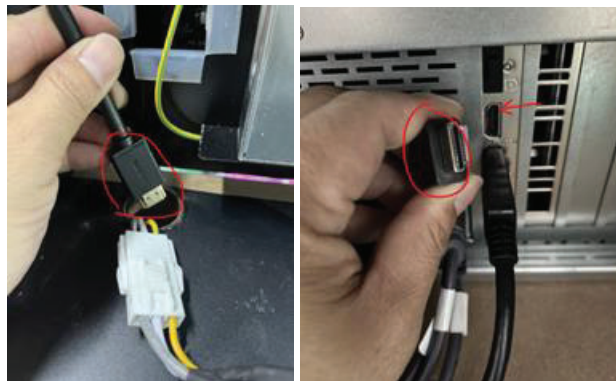

Step 8. Fix the back cover to the LED PANEL ASSY.



Step 9. Remove the back cover of the seat.



Step 10. Stick corresponding numbers on the back cover according to the machine number.

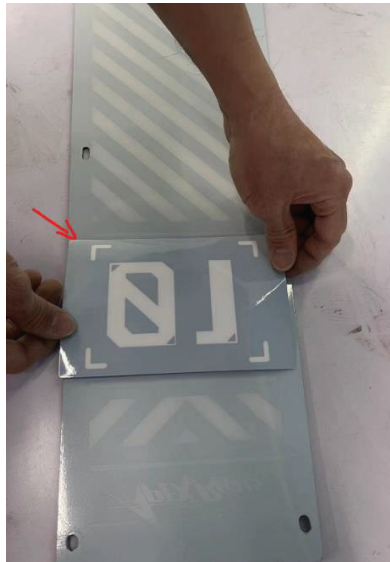

Step 11. Fix the back cover to the seat.

Step 12. Remove the cover of the rear ASSY.

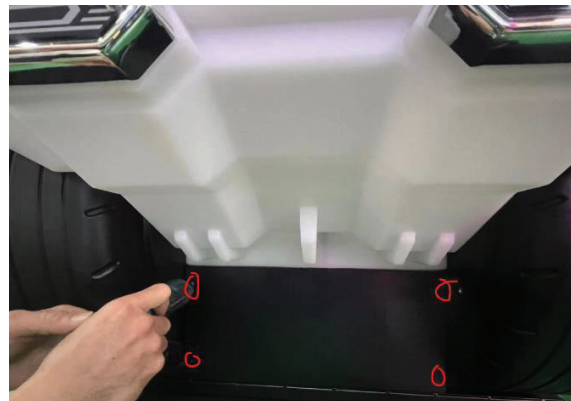

Step 13. Fix the rear ASSY to the seat ASSY and connect the wiring harnesses.



Step 14. Fix the cover to the rear ASSY.

Step 15. Fix the connection frame to the seat frame with spacing columns and screws.

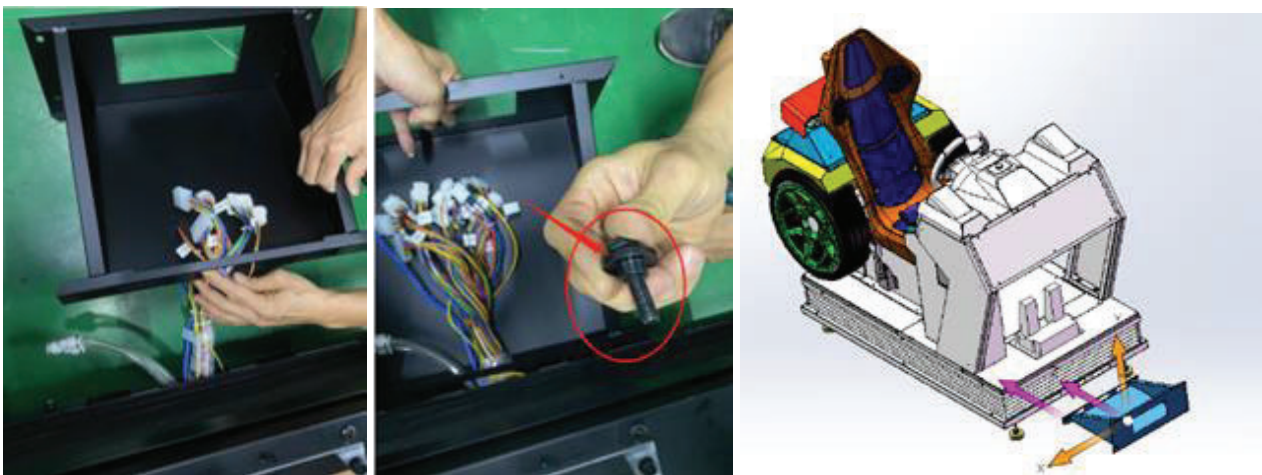

Step 16. Fix the connection frame to the monitor frame (4 screws).

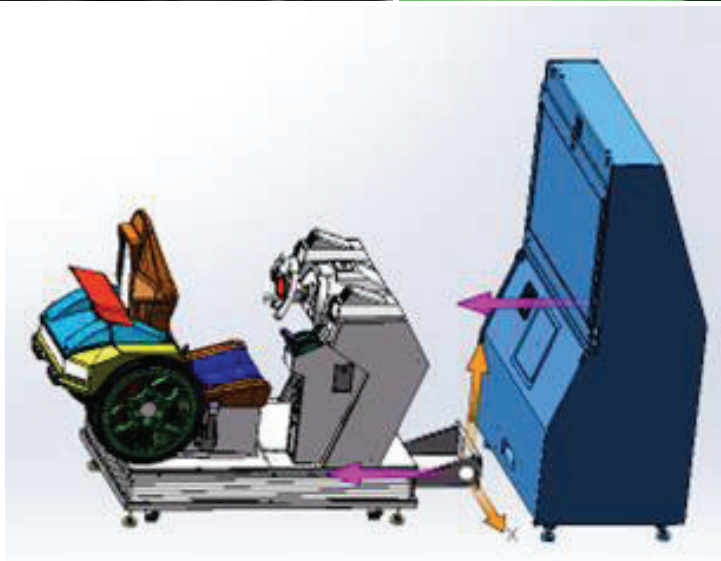
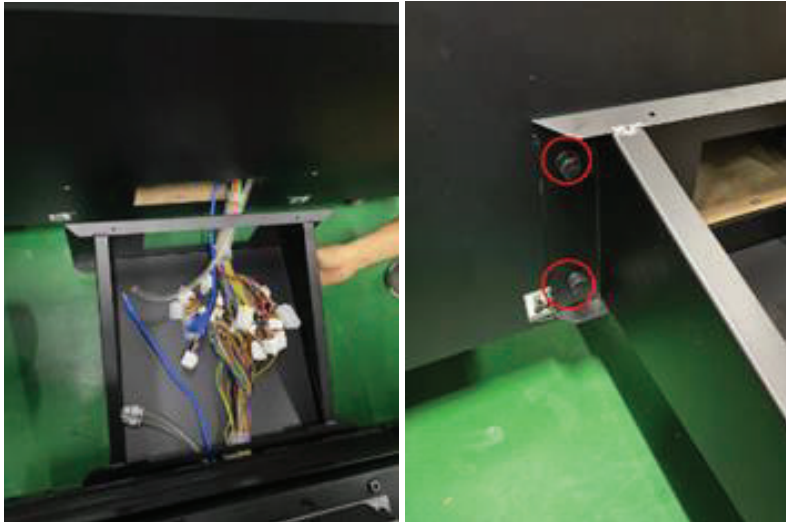

Step 17. Connect all wires and air pipes.

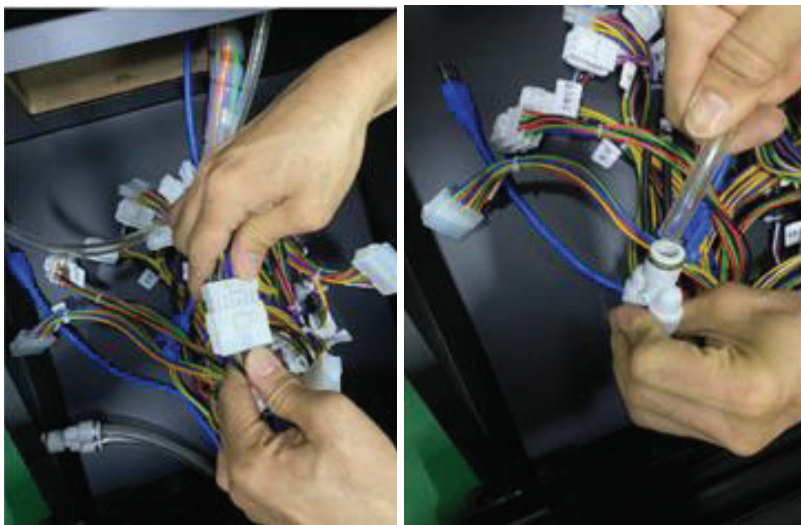

Step 18. Fix the cover plate on the connection frame.

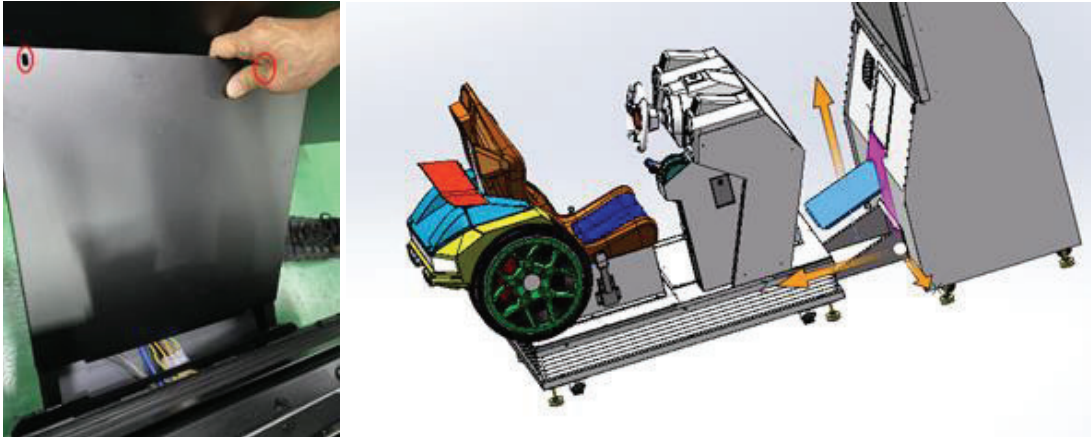

Step 19. Fix the flag to the monitor frame.



Step 20. Close all the doors.
The cabinet assembly is completed.