

### WARNING

- Perform assembly work by following the procedure herein stated. Failure to comply with the instructions can cause electric shock
- **Perform assembling as per this Manual. Since this is a complex machine, incorrect assembling can cause an electric shock, machine damage and/or improper functioning as per specified performance**
- When assembling, more than one person is required. Depending on the assembly work, there are some cases in which working by one person alone can cause personal injury or parts damage
- **Ensure that connectors are properly connected. Improper connections can cause electric shock**
- Be careful not to damage the wires. Damaged wires may cause electric shock or short circuit or present a risk of fire
- **This work should be carried out by site maintenance personnel or other qualified professionals. Work performed by non-technical personnel can cause a severe accident such as electric shock. Failing to comply with this instruction can cause a severe accident such as electric shock to the player during operation. If no one with proper technological expertise is available, request service from the office indicated in this document or the point of purchase so as to ensure safety**
- Provide sufficient space so that assembling can be performed. Performing work in places with narrow space or low ceiling may cause an accident and assembly work to be difficult
- **To perform work safely and avoid serious accident such as the Cabinet falling down, do not perform work in places where step-like grade differences, a ditch, or slope exist**
- Do not leave power cords or Ground Wires exposed in areas of heavy foot traffic. Doing so may cause them to become damaged, possibly resulting in electric shock and/or short circuits. When laying wiring across the floor, always use safety covers to protect the wires. (Wiring diameter: power cable - approx. ~ 8)
- **Have a flashlight or another supplementary lighting unit available while working. With indoor lighting alone, the Cabinet interior may be too dark. Working without proper lighting can lead to accidents. It also hinders proper work performance**
- The Cabinet has ventilation ports. Be sure not to block them. If they are blocked, heat can build up, leading to fire. This can also accelerate wearing of parts and malfunctions
- **Secure ample ventilation space around the Cabinet. If heat builds up, there could be accidents associated with heat or smoke generation**
- This product does not use any connectors other than those connected to and used by the Game Board when it leaves the factory. Do not needlessly connect wires to unused connectors. This could lead to overheating, generation of smoke and burn related injuries





## CAUTION

- Handle molded parts with care. Excessive weight or pressure may cause them to break and the broken pieces may cause injury
- **To perform the operations at height safely and accurately you must use a safe, steady footstool or stepladder. Working without this may lead to a fall and possible injury**
- When attaching or removing doors or lids, be careful that your hand or finger does not get caught in anything

## INSTALLATION PROCESS

### IMPORTANT!

- Be careful not to damage parts surfaces. In some cases, if such surfaces are damaged, the part must be replaced; it cannot be reinforced or repaired
- **Ensure to carry out the installation with a minimum of 2 people**

**1** Secure the acrylic panel with 9 x fixings

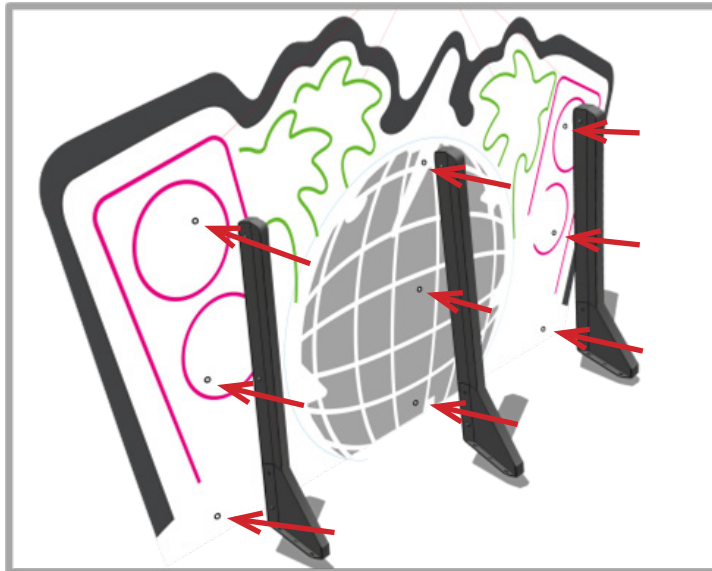

**2** Secure the top Cabinet brackets with 6 x fixings

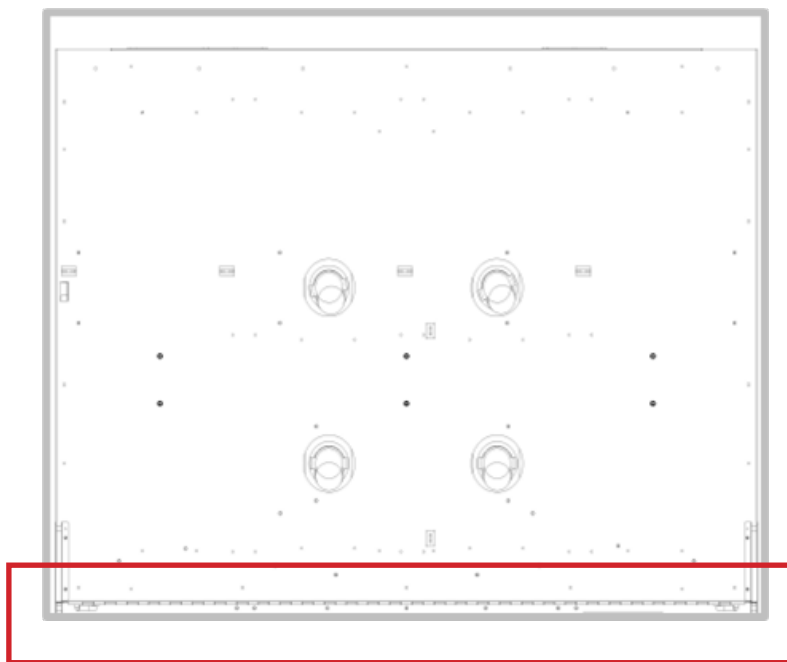

**3** Secure the PVC with 4 x fixings

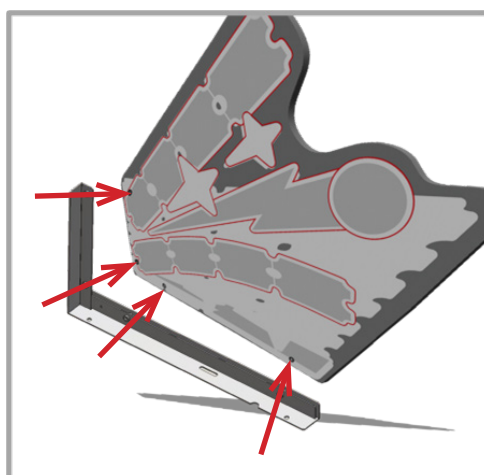

**4** Secure the top Cabinet brackets with 6 x fixings

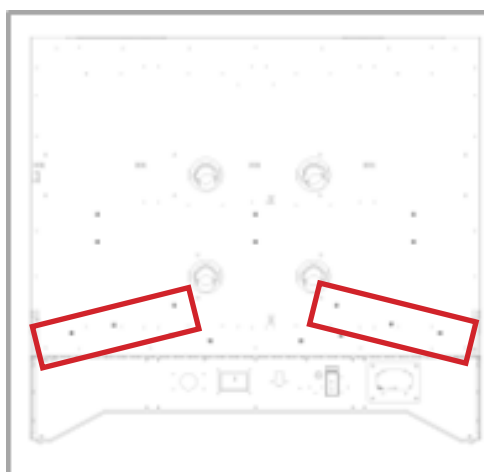

**5** Secure the Logo with 5 x fixings

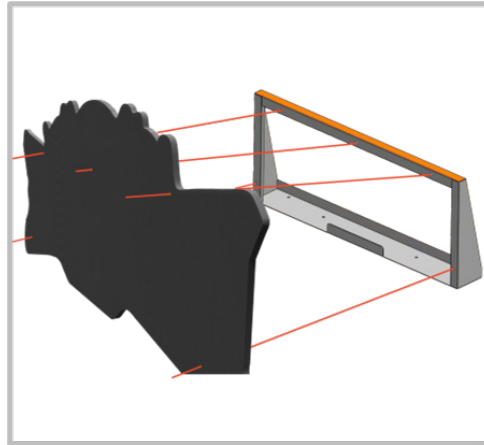

**6** Secure the top Cabinet brackets with 4 x fixings

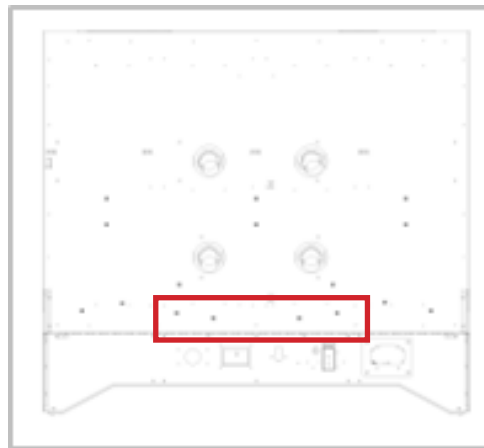

**7** Insert Tree acrylic into position and secure with 7 x fixings

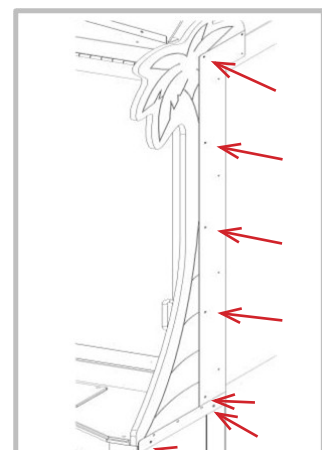
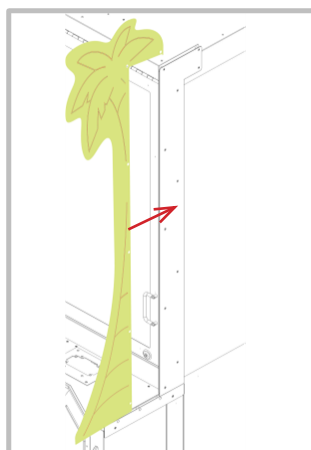

## FIXATION TO INSTALLATION SITE

### WARNING

**Make sure that all the adjusters contact the floor. Otherwise the Cabinet could move, causing an accident**

The product comes with castors and adjusters at multiple locations. When the installation site has been determined, have the adjusters come in direct contact with the floor. Establish a gap of at least 5 mm between the floor and the castors and adjust the unit so that it will remain level.

- 1** Move the product to the installation site. If the product is to be installed near a wall, secure enough passageway space for players to access the seat. You must also secure a 15cm space between the back wall and the back of the cabinet for ventilation
- 2** Bring the adjusters into direct contact with the floor. Use a wrench to align the height of the adjusters until the Cabinet is perfectly level
- 3** After setting, turn adjuster nuts upwards to tighten them and secure adjuster heights

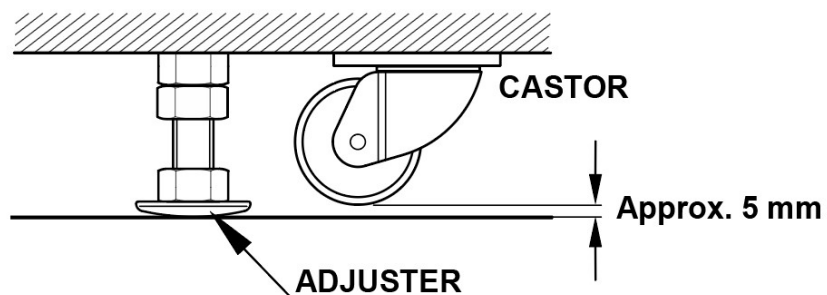
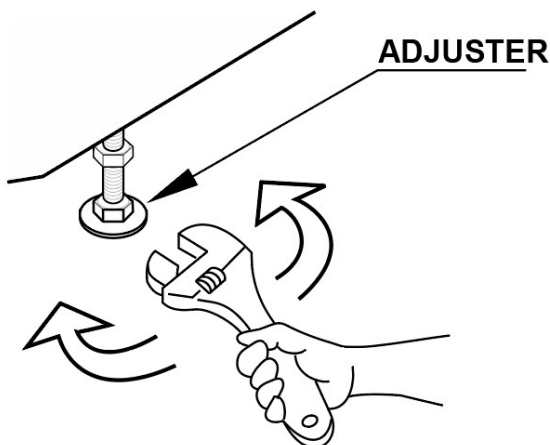



## CONNECTION OF POWER AND GROUND CABLES

(Only applies where an integral earth is not present in the mains/power lead.)

### WARNING

- Use the power supply equipped with an earth leakage breaker. Use of power supply without such a breaker could result in fire if there is a current leakage
- **Have available a securely grounded indoor ground terminal. Without proper grounding, customers could be electrocuted and product operations might not always be stable**
- Do not expose the power cord or ground wire. If these are exposed, customers could stumble over them, for instance, and easily damage them. Additionally, if these lines are damaged, there could be a risk of electrical shock or short circuit. Set these lines at locations where they will not interfere with customer traffic, or attach covers to them
- **After laying out the power cord on the floor, be sure to always protect it. If the power cord is left exposed, it can easily be damaged, resulting in electrical shock**
- When using the product's AC unit ground terminal, use ground wire with a circular terminal as shown in the illustration, and establish ground securely. Avoid indiscriminate grounding operations such as use of wire with only its sheath peeled off

### IMPORTANT!

If grounding has been established with the ground wire inside the power cord, do not perform grounding with the AC unit ground terminal.

Conversely, if the AC unit ground terminal has been used for grounding, do not establish ground with the ground wire in the power cord. Otherwise there could be faulty or erroneous operations

- 
- 1** Confirm that the Mains Switch is at **OFF**

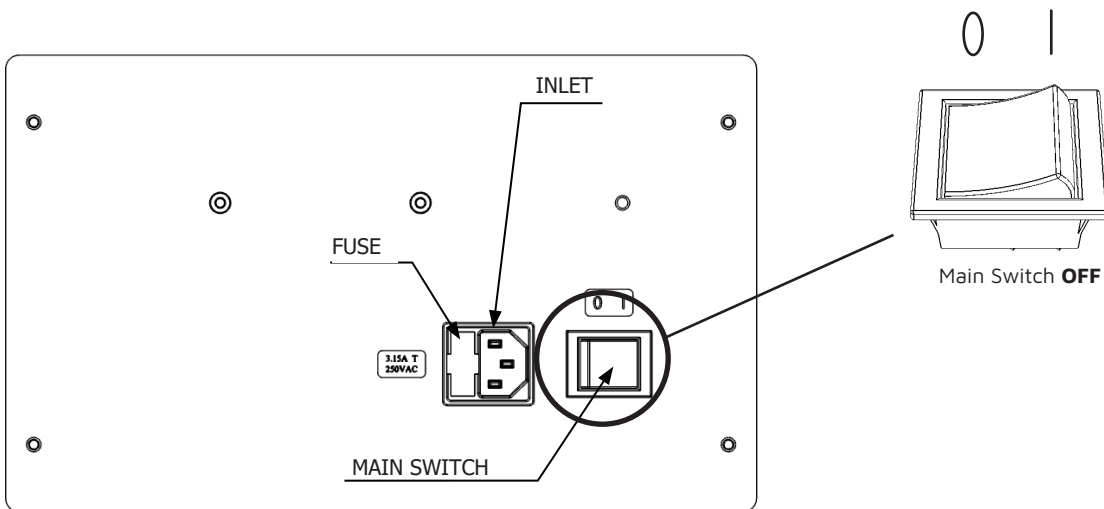

- 
- 2** Fully insert the power cord connector on the side opposite the power plug into the AC unit inlet

- 
- 3** Fully insert the power cord plug into the outlet

- 
- 4** The power cord is laid out indoors. Protect the power cord by attaching wire cover to it. If ground will be established with a ground wire made available separately, lay out the ground wire indoors and have it protected

